



# QuickSteamer®

## USER'S GUIDE 1770, 1970, 2080, 2090 SERIES

3 Safety Instructions

4 Product View

5 Assembly

6-8 Operation

8-9 Maintenance and Care

10 Troubleshooting

10 Consumer Services

11 Replacement Parts

12 Warranty



## Thanks for buying a BISSELL QuickSteamer®

We're glad you purchased a BISSELL QuickSteamer lightweight deep cleaner. Everything we know about floor care went into the design and construction of this complete, high-tech home cleaning system.

Your QuickSteamer is well made, and we back it with a limited one-year warranty. We also stand behind it with a knowledgeable, dedicated Consumer Services department, so, should you ever have a problem, you'll receive fast, considerate assistance.

My great-grandfather invented the floor sweeper in 1876. Today, BISSELL is a global leader in the design, manufacture, and service of high quality homecare products like your QuickSteamer.

Thanks again, from all of us at BISSELL.

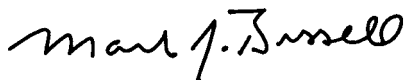

**Mark J. Bissell**

**President and Chief Executive Officer**

# IMPORTANT SAFETY INSTRUCTIONS

When using an electrical appliance, basic precautions should be observed, including the following:

Read all instructions before using your QUICKSTEAMER®

**⚠ WARNING:** To reduce the risk of fire, electric shock, or injury:

- Do not immerse.
- Use only on surfaces moistened by cleaning process.
- Always connect to a properly grounded outlet. See Grounding Instructions.
- Unplug from outlet when not in use and before conducting maintenance or troubleshooting.
- Do not leave machine when it is plugged in.
- Do not service machine when it is plugged in.
- Do not use with damaged cord or plug.
- If appliance is not working as it should, has been dropped, damaged, left outdoors, or dropped into water, have it repaired at an authorized Service Center.
- Do not expose to rain. Store indoors.
- Do not pull or carry by cord, use cord as a handle, close door on cord, pull cord around sharp corners or edges, run appliance over cord, or expose cord to heated surfaces.
- Do not carry the appliance while in use.
- Do not unplug by pulling on cord. Unplug by grasping the plug, not the cord.
- Do not handle plug or appliance with wet hands.
- Do not put any object into appliance openings, use with blocked opening, or restrict air flow.
- Do not expose hair, loose clothing, fingers or body parts to openings or moving parts.
- Do not pick up hot or burning objects.
- Do not pick up flammable or combustible materials (lighter fluid, gasoline, kerosene, etc.) or use in the presence of explosive liquids or vapor.
- Do not use appliance in an enclosed space filled with vapors given off by oil base paint, paint thinner, some moth proofing substances, flammable dust, or other explosive or toxic vapors.
- Do not pick up toxic material (chlorine bleach, ammonia, drain cleaner, gasoline, etc.).
- Do not modify the 3-prong grounded plug.
- Do not allow to be used as a toy.
- Do not use for any purpose other than described in this User's Guide.
- Use only manufacturer's recommended attachments.
- Use only cleaning products formulated by BISSELL for use in this appliance to prevent internal component damage. See the Cleaning Fluid section of this guide.
- Keep openings free of dust, lint, hair, etc.
- Keep appliance on a level surface.
- Turn off all controls before unplugging.
- Be extra careful when cleaning stairs.

- Close attention is necessary when used by or near children.

**WARNING:** The Power Cord on this product contains lead, a chemical known to the State of California to cause birth defects or other reproductive harm.

**WASH HANDS AFTER HANDLING.**

## SAVE THESE INSTRUCTIONS.

THIS MODEL IS FOR HOUSEHOLD USE ONLY. Commercial use of this unit voids the manufacturer's warranty.

## GROUNDING INSTRUCTIONS

This appliance must be connected to a grounded wiring system. If it should malfunction or break down, grounding provides a safe path of least resistance for electrical current, reducing the risk of electrical shock. The cord for this appliance has an equipment-grounding conductor and a grounding plug. It must only be plugged into an outlet that is properly installed and grounded in accordance with all local codes and ordinances.

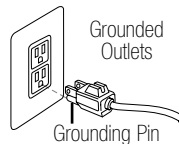

**⚠ WARNING:** Improper connection of the equipment-grounding conductor can result in a risk of electrical shock. Check with a qualified electrician or service person if you aren't sure if the outlet is properly grounded. **DO NOT MODIFY THE PLUG.** If it will not fit the outlet, have a proper outlet installed by a qualified electrician. This appliance is designed for use on a nominal 120-volt circuit, and has a grounding attachment plug that looks like the plug in the drawing above. Make certain that the appliance is connected to an outlet having the same configuration as the plug. No plug adapter should be used with this appliance.

## Product View

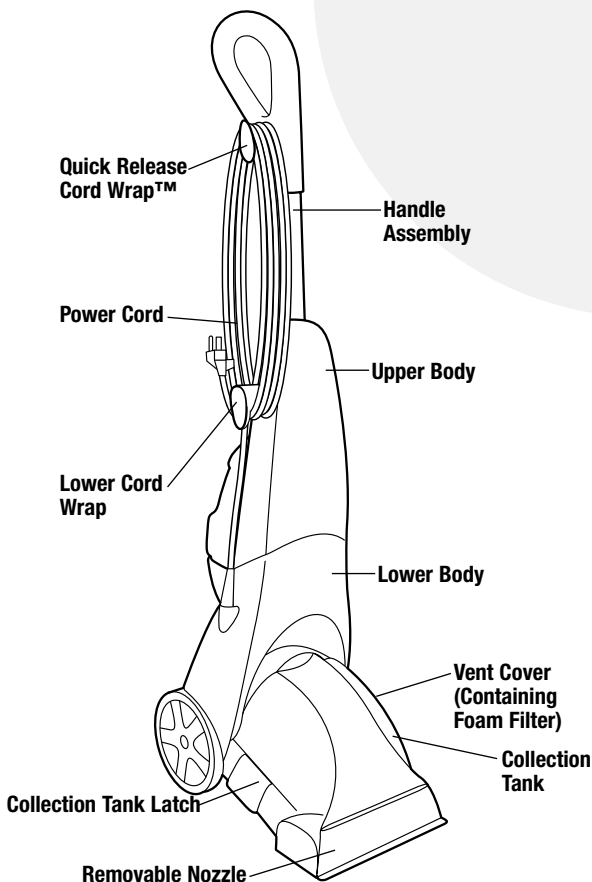
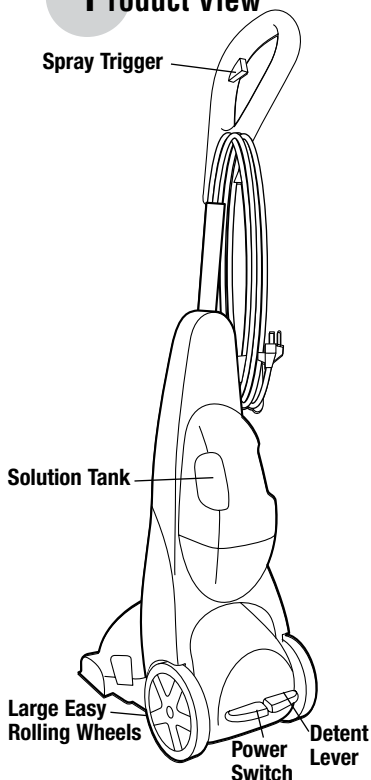

## WARNING:

To reduce the risk of fire and electric shock due to internal component damage, use only BISELL cleaning fluids intended for use with the deep cleaner. Non-BISELL cleaning solutions may harm the machine and void the warranty.

## Cleaning fluid

Keep plenty of genuine BISELL Fiber Cleansing Formula™ on hand so you can clean and protect whenever it fits your schedule. Always use genuine BISELL deep cleaning formulas. Non-BISELL cleaning solutions may harm the machine and will void the warranty.



48 oz. BISELL Fiber Cleansing Formula™ with Scotchgard™ Protector  
**item # 0710**



48 oz. BISELL Multi- Allergen Removal™ with Scotchgard™ Protector  
**item # 0720**



48 oz. BISELL Pet Odor and Soil Removal™ Formula with Scotchgard™ Protector  
**item # 0730**



48 oz. BISELL Natural Orange Extract Formula with Scotchgard™ Protector  
**item # 0740**



48 oz. BISELL Lavender Essence Formula with Scotchgard™ Protector  
**item # 0750**



43 oz. BISELL 3X Concentrated Fiber Cleansing Formula with Scotchgard™ Protector  
**# 0716**



32 oz. BISELL Hard Floor Solutions™ Formula  
**item # 0484**



22 oz. BISELL Tough Stain PreCleaner™  
**item # 0400**

# How to Use this Guide

This user's guide has been designed to help you get the utmost satisfaction from your BISSELL QuickSteamer lightweight deep cleaner. You'll find assembly and operating instructions, safety precautions, as well as maintenance and troubleshooting instructions. Please read this guide thoroughly before assembling your deep cleaner. Pay particular attention to the product diagram, assembly instructions, and part names. Locate and organize all parts before assembly. Familiarize yourself with the parts and where they go. Following this user's guide will greatly enhance your ability to get the most performance from your BISSELL QuickSteamer for many years.

Your QuickSteamer comes in three, easy to assemble components:

- Handle assembly
- Upper body assembly
- Solution tank

Also includes 3 Phillips head screws.

The only thing you will need to assemble your cleaner is a Phillips head  screwdriver.

## Assembly

1. Slide upper body into lower body.
2. Secure with screws.
3. Slide handle assembly down into upper body until it will go no further. Align screw slots.
4. Secure with screw.
5. Place solution tank on back of unit.

## Product features

### Solution Tank:

Holds 1/2-gallon of cleaning solution.

### Collection Tank:

Holds 1/2-gallon of dirty water.

### Power Cord:

For storage, wrap power cord around upper and lower cord wraps, and secure plug to cord with molded clip.

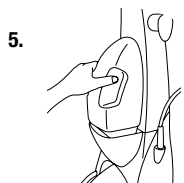
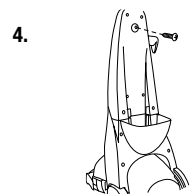
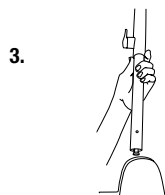
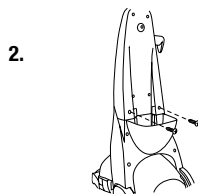
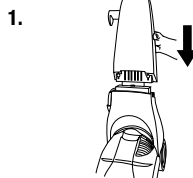

# Operation

## Before you clean

1. Plan activities to give carpet time to dry.
2. Remove easily moved furniture (chairs, lamps, coffee/cocktail tables, etc.) from room if needed.
3. Vacuum carpet thoroughly.
4. Decide where to begin — and end — your job. Clean in 3' X 4' sections, starting in areas farthest from exit. Plan to leave a path open to empty soiled water and refill cleaner.
5. Carpeting will dry in three to four hours, depending on carpet style and air circulation in room. A floor fan speeds drying.
6. Replace furniture on damp carpeting by placing waxed paper under legs until floor dries completely.

## Fill the tank

1. Remove the solution tank by lifting it straight up, then away from the lower body.
2. Unscrew the black cap at the bottom of the solution tank.
- 3a. Add one of the BISSELL advanced cleaning formulas for deep cleaning machines to the formula fill line on the solution tank. Fill the rest of the tank with hot (not boiling) tap water to the water fill line. Replace and tighten the black cap.
- 3b. If using the BISSELL 3X Concentrated Fiber Cleansing Formula: Add 1/2 capful of 3X Concentrated Fiber Cleansing formula to clean water/solution tank, and then fill with hot water to the line.
4. Place solution tank on lower body.
5. Rotate Quick Release Cord Wrap™ to release the Power cord and plug into an outlet.

## Pre-Treating

### **Pre-treat stubborn stains and highly soiled carpet in hallways and other high-traffic areas.**

1. Using BISSELL Tough Stain pre-cleaner, generously spray evenly over soiled area, do not overwet carpet.
2. Wait 3 -5 minutes before deep cleaning.

## **WARNING:**

To reduce the risk of fire, use only BISSELL advanced cleaning formulas for deep cleaning machines. Use of cleaning formulas that contain lemon or pine oil may damage this appliance and void warranty. Chemical spot cleaners or solvent-based soil removers should not be used. These products may react with the plastic materials used in your QuickSteamer, causing cracking or pitting.

## *Tip:*

Always vacuum thoroughly before you deep clean. If possible, move large furniture to an area you will not be cleaning.

2.



## *Tip:*

Deep cleaning spots, spills and high traffic areas on a regular basis can prolong carpet life.

# Operation

## Carpet cleaning

1. With your foot, press the red power switch [located in foot of unit] ON.
2. With foot, press the detent lever on right side of lower body.
3. Depress spray trigger to spray cleaning solution. **Do not overwet.**
4. To suction up water, repeat motion over same area without pressing trigger.
5. Repeat steps 3 and 4 until no more dirt can be removed.
6. Continue to clean entire carpet, working in 3' x 4' sections.
7. Empty the collection tank when dirty water reaches the full line, or when the solution tank is empty. See page 8 for instructions.
8. If floor nozzle stops spraying, turn power switch OFF and check water and cleaning solution levels. Refill if needed.

### Tip:

It is recommended that every time your solution tank needs refilling, that you empty the contents of the collection tank. If the collection tank gets too full, you may begin to see foam spitting out of the vent cover. If this happens empty the collection tank.

## To empty the collection tank

1. Turn power switch OFF.
2. Unplug power cord from outlet.
3. Remove and empty collection tank.
  - a. Release collection tank latches [1 each side] by pulling up from bottom of latch and then out.
  - b. Carefully remove collection tank from lower body by lifting handle.
  - c. Carry collection tank to a toilet or sink. To empty, pour out contents using opening at back of tank.
  - d. Rinse collection tank thoroughly.
  - e. Remove lint and hair from red gasket in base of unit. **(Do not remove gasket)**
4. Clean nozzle window by lifting latch and removing from machine. Rinse under running water. When finished replace nozzle and secure with latch.
5. Replace collection tank on lower body and secure with latches.

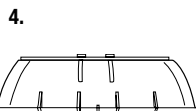
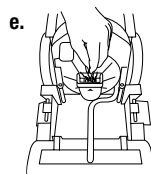
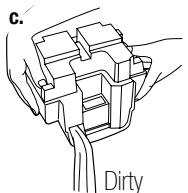
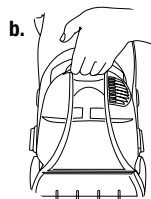
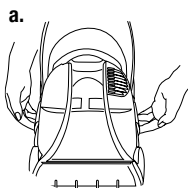

## Hard floor cleaning

1. Attach hard floor tool to unit.
2. Remove the collection tank (refer to steps 3a and b in the Maintenance and care section on page 8)
  - A. **For 1770/1970 series it is necessary to remove the cross action brush first.** Using your thumbs squeeze the 2 grey tabs towards the outside of the unit. Push down at the same time and release the cross action brush.

## Operation

### Hard floor cleaning (continued)

3. Attach the hard floor tool by hooking it into the front of the removable nozzle and swinging it down until the tabs pop into place.
4. Replace the collection tank. Be sure to attach the 2 latches.
5. Fill solution tank with BISSELL Hard Floor Solutions™ to FORMULA fill line.
6. Fill solution tank with hot (not boiling) tap water to the WATER fill line.
7. Follow steps 1-8 in Carpet cleaning section above.

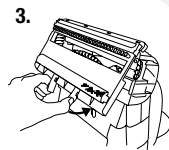

2080/2090 series

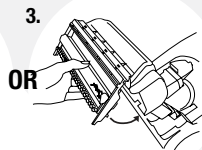

OR

1770/1970 series

## Maintenance and care

### Machine storage

1. Wrap power cord around Quick Release Cord Wrap™ on side of QUICKSTEAMER®.
2. Wipe all surfaces with a soft cloth. Store cleaner upright in a protected, dry area.  
**NOTE: You may have cleaning solution remaining in the clean/solution tank. You may store your QuickSteamer this way for the next cleaning task, but never keep soiled solution in the collection tank.**



### **WARNING:**

To reduce the risk of injury from moving parts and/or electrical shock, turn power switch OFF and disconnect plug from electrical outlet before performing maintenance or troubleshooting checks.



### **CAUTION:**

Do not store unit where freezing may occur. Damage to internal components may result.



# Maintenance and care

## To install the replacement brush belt

### \*QuickSteamer PowerBrush models only

1. Turn the machine off and unplug from wall outlet.
2. Remove solution and collection tanks.
3. Lie machine down to access the bottom of the machine.
4. With a Phillips head screwdriver,  unscrew the brush cover and remove.
5. Remove the brush end cap and remove belt from brush.
6. Brush can now be removed.
7. Belt can be removed by sliding off the motor pulley.
8. Clean or replace belt. Attach belt to motor pulley and brush, insert brush into right side end cap.
9. Reattach the left end cap and slide brush back into place.
10. Replace the brush cover and screw into place.

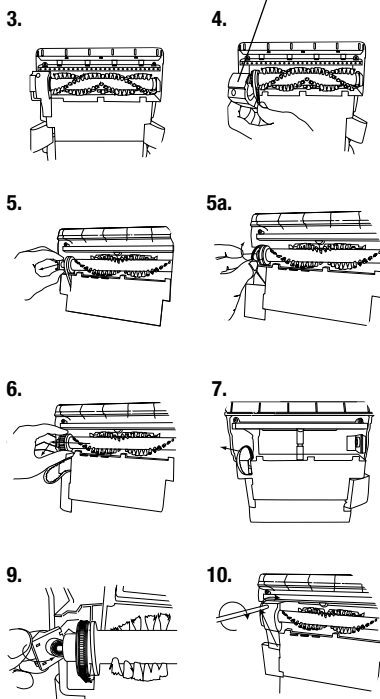

# Troubleshooting

## Reduced spray or no spray

### Possible Cause

1. Clean tank empty
2. Lint screen on solution tank cap clogged

### Remedy

1. Refill tank with water and formula
2. Soak solution tank cap in warm water and then rinse under running water

## Deep cleaner not picking up cleaning solution

### Possible Cause

1. Collection tank not aligned/secured
2. Dirty tank full
3. Removable nozzle installed improperly

### Remedy

1. Check tank proper alignment and secure with side latches
2. Empty tank
3. Align four "hooks" into bottom first, then snap into place on top

## Troubleshooting

### Deep cleaner not picking up cleaning solution (Continued)

#### Possible Cause

4. Removable nozzle full of debris
5. Red lint screen under collection tank clogged

#### Remedy

4. Remove nozzle and rinse under running water
5. Remove debris from lint screen

**Other Maintenance or Service not included above should be performed by an authorized service representative.**

**Thank you for selecting a BISSELL product.**

**Please do not return this product to the store**

**For any questions or concerns, BISSELL is happy to be of service.**

**Contact us directly at 1-800-237-7691.**

## BISSELL Consumer Services

For information about repairs or replacement parts, or questions about your warranty, call:

### **BISSELL Consumer Services**

**1-800-237-7691**

Monday - Friday 8 a.m. — 10 p.m. ET

Saturday 9 a.m. — 8 p.m. ET

Or write:

BISSELL HOMECARE, INC

PO Box 3606

Grand Rapids MI 49501

ATTN: Consumer Services

Or visit the BISSELL website - **[www.bissell.com](http://www.bissell.com)**

When contacting BISSELL, have model number of unit available.

Please record your Model Number: \_\_\_\_\_

Please record your Purchase Date: \_\_\_\_\_

**NOTE: Please keep your original sales receipt. It provides proof of date of purchase in the event of a warranty claim. See "Warranty" on page 12 for details.**

**Please register your new BISSELL product at  
[www.bissell.com/productregistration](http://www.bissell.com/productregistration)**

# Replacement parts - BISSELL QuickSteamer

Item	Part No.	Part Name
<b>QuickSteamer – 1770/1970 Series</b>		
1	203-5519	Handle Assembly
2	203-5545	Cross Action Brush
3	203-5537	Solution Tank (Includes Cap and Insert Assembly)
4	203-5522	Collection Tank
5	203-5547	Hard Floor Tool
6	203-5541	Solution Tank Cap and Insert Assembly
<b>QuickSteamer PowerBrush – 2080/2090 Series</b>		
1	203-5520	Handle Assembly
3	203-5540	Solution Tank (Includes Cap and Insert Assembly)
4	203-5523	Collection Tank
6	203-5541	Solution Tank Cap and Insert Assembly
7	203-5546	DirtLifter® PowerBrush
8	203-5549	Belt
9	203-5548	Hard Floor Tool
<b>Formulas:</b>		
10	0710A	Fiber Cleansing Formula™ 48 oz.
11	0716	3x Concentrated Fiber Cleansing Formula with Scotchgard™ Protector 43 oz.
12	0720A	Multi-Allergen Removal™ Formula 48 oz.
13	222-0400	Tough Stain PreCleaner™
14	0730A	Pet Odor and Soil Removal Formula 48 oz.
15	0484	Hard Floor Solutions 32 oz.

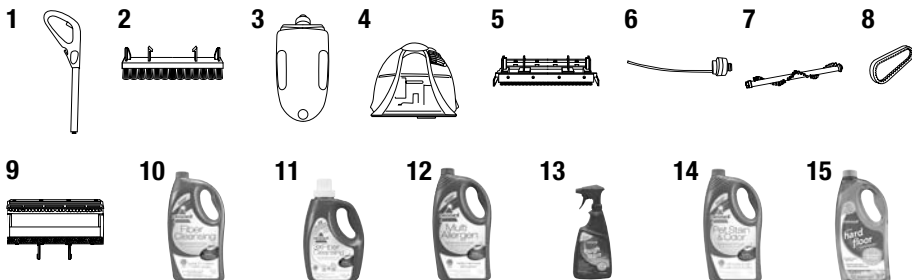

## Earn Rewards Points!

To qualify you for discounts, rebates, and other BISSELL perks.  
Visit [www.bissell.com/rewards](http://www.bissell.com/rewards) to learn more.

# Warranty - BISSELL QuickSteamer

This warranty gives you specific legal rights, and you may also have other rights which may vary from state to state. If you need additional instruction regarding this warranty or have questions regarding what it may cover, please contact BISSELL Consumer Services by E-mail, telephone, or regular mail as described below.

## Limited One Year Warranty

Subject to the **\*EXCEPTIONS AND EXCLUSIONS** identified below, upon receipt of the product BISSELL Homecare, Inc. will repair or replace (with new or remanufactured components or products), at BISSELL's option, free of charge from the date of purchase by the original purchaser, for one year any defective or malfunctioning part.

See information below on "If your BISSELL product should require service".

This warranty applies to product used for personal, and not commercial or rental service. This warranty does not apply to fans or routine maintenance components such as filters, belts, or brushes. Damage or malfunction caused by negligence, abuse, neglect, unauthorized repair, or any other use not in accordance with the User's Guide is not covered.

## If your BISSELL product should require service:

Contact BISSELL Consumer Services to locate a BISSELL Authorized Service Center in your area.

If you need information about repairs or replacement parts, or if you have questions about your warranty, contact BISSELL Consumer Services.

### Website or E-mail:

[www.bissell.com](http://www.bissell.com)

Use the "Customer Services" tab.

### Or Call:

BISSELL Consumer Services

1-800-237-7691

Monday - Friday 8 a.m. - 10 p.m. ET

Saturday 9 a.m. - 8 p.m. ET

### Or write:

BISSELL Homecare, Inc.

PO Box 3606

Grand Rapids MI 49501

ATTN: Consumer Services

BISSELL HOME CARE, INC. IS NOT LIABLE FOR INCIDENTAL OR CONSEQUENTIAL DAMAGES OF ANY NATURE ASSOCIATED WITH THE USE OF THIS PRODUCT. BISSELL'S LIABILITY WILL NOT EXCEED THE PURCHASE PRICE OF THE PRODUCT.

**Some states do not allow the exclusion or limitation of incidental or consequential damages, so the above limitation or exclusion may not apply to you.**

### \*EXCEPTIONS AND EXCLUSIONS FROM THE TERMS OF THE LIMITED WARRANTY

THIS WARRANTY IS EXCLUSIVE AND IN LIEU OF ANY OTHER WARRANTIES EITHER ORAL OR WRITTEN. ANY IMPLIED WARRANTIES WHICH MAY ARISE BY OPERATION OF LAW, INCLUDING THE IMPLIED WARRANTIES OF MERCHANTABILITY AND FITNESS FOR A PARTICULAR PURPOSE, ARE LIMITED TO THE ONE YEAR DURATION FROM THE DATE OF PURCHASE AS DESCRIBED ABOVE.

Some states do not allow limitations on how long an implied warranty lasts, so the above limitation may not apply to you.

**NOTE: Please keep your original sales receipt, it is your warranty.**



©2008 BISSELL Homecare, Inc.  
Grand Rapids, Michigan  
All rights reserved. Printed in China  
Part Number 120-4071  
Rev 09/08  
Visit our website at:  
[www.bissell.com](http://www.bissell.com)

Scotchgard is a trademark of 3M

